

City Manager Announces Balanced Budget



City Manager
Nancy Kerry

For the first time in five years, balancing the budget did not require the use of general fund reserves, other excess reserves, staffing reductions or service reductions.

Balancing the FY 2014 budget is possible because during the last several years the City confronted its long-term structural deficit realities by making the difficult, but necessary decisions. While balancing the budget within expected revenues might create the impression we're out of the woods, it's important to note, *we are not*. The unrelenting rise in the cost of employee pensions is expected to easily devour conservative gains in revenue in the coming years.

In fact, had the City not been able to implement the first step in our three step

approach to solving our fiscally unsustainable health care program in this year's budget, the *budget would not have been balanced*. However, we did balance the budget because the City of South Lake Tahoe employees accepted responsibility and are beginning to understand the major budget issues. In previous years, employees have agreed to furloughs and reductions in pay to contribute the entire employee share of pension costs (ranging from 7% to 9%), and taken on much higher levels of work due to the loss of 30% of the workforce.

This year, the employee Health Care Cost Containment Committee and all labor groups worked with the City Manager and the new health insurance broker to implement the first step toward solving our unsustainable health care benefit plan. These contributions by employees helped achieve a balanced budget.

The FY 2014 balanced budget maintains core services through the adoption of a new budget philosophy: prudent, conservative and *realistic*. The budget was built for *expected* rather than *projected* revenues and expenses. Although revenue

projections for FY 2013 are better than anticipated, FY 2014 budget relies on stable, rather than anticipated, revenues. The new budget philosophy recognizes the City is on the right track which began several years ago. If revenues exceed expectations, the City Council will have the opportunity at mid-year, for the first time in several years, to determine the best **investment strategy** to rebuild, restore and revitalize the community. We must stay focused on the vision that the future of the City of South Lake Tahoe and in fact all of the South Shore is contingent upon where we invest our revenue increases, which should be in our community's infrastructure and our prime industry, recreation.

This year we will continue to deliver what the community expects by demonstrating our commitment to providing the necessary resources to ensure the community is well protected, well served and understands our commitment to excellent public service.

The complete Budget Message is available online at www.cityofslt.us.

IN THIS ISSUE

- ◆ City Manager Announces Balanced Budget
- ◆ City Appoints New Fire Chief
- ◆ National Lead Poisoning Prevention Week
- ◆ SLTFD Goes PINK for the Cure
- ◆ Take the Parks Survey
- ◆ Ribbon Cutting for Dog Agility Course
- ◆ Vail volunteers for Bijou Community Park
- ◆ Caltrans Ribbon Cutting
- ◆ Light up South Lake Tahoe
- ◆ 2013 K9 Trials
- ◆ Calendar
- ◆ Important phone numbers

City Appoints Jeffrey Meston as Fire Chief

City Manager Nancy Kerry announced the appointment of Jeffrey Meston as South Lake Tahoe Fire Departments new Fire Chief at the October 1st City Council meeting.



SLTFD Fire Chief
Jeff Meston

After a 30+ year career in fire service, retirement from the Novato Fire District, and over seven years of private consulting, Chief Meston brings his knowledge of team building, planning and leadership training to South Lake Tahoe.

Chief Meston holds a Master's Degree in Public Administration, was certified as a Firefighter 1, Firefighter 2 (the first in California), Driver Operator, Fire Officer,

Chief Officer and Fire Chief. He is a Chief Fire Officer Designee with the International Association of Fire Chiefs and a graduate of the Executive Fire Officers program at the national Fire Academy.

"I'm enthusiastic about joining South Lake Tahoe Fire Department and look forward to helping them grow and develop in their own careers," said Chief Meston. "There are several people working in newer positions within SLTFD and I look forward to sharing my own experiences to support a dynamic team."

Chief Meston's accomplishments includes creating a citizen disaster preparedness training program for business and homeowners groups which won an International Association of Fire Chiefs (IAFC) National Award, and appointment by the State Fire Marshal to serve on the State Training and Education Committee (STEAC).

**October 20-26, 2013 is National Lead Poisoning Prevention Week
October 20th-26th**



Lead is highly toxic and can harm your child's brain, causing lifelong learning and behavior problems. Children under age six are most at risk for lead poisoning, but there are also significant health risks for adults, newborns and pregnant women too.

Lead dust in the home is caused by chipping, peeling, flaking or deteriorating lead-based paint. Lead dust is not the same as household dust. Lead dust equivalent of only three granules of sugar can begin to poison a child.

If your home was built before 1978, lead paint may still be on the walls, doors, windows and sills.

The City of South Lake Tahoe's Lead Safe Tahoe team is working to identify houses and apartments within city limits that have lead-based paint hazards. Learn more about the City's free Lead Hazard program at www.CityofSLT.us/LeadSafeTahoe or call (530) 542-6011.

South Lake Tahoe Fire Department (SLTFD) Goes PINK for the Cure

T-shirts in support of Breast Cancer Awareness month are for sale for \$20 at SLTFD Station 3 located at 2101 Lake Tahoe Blvd. (near the Y). Stop by Station 3 today to support this important cause! SLTFD Station 3 (530) 542-6063.



1st Annual Breast Cancer Awareness Fundraiser

South Lake Tahoe Fire Department and Tahoe Bowl are partnering for the 1st Annual Breast Cancer

Awareness fundraiser on Friday, October 25th from 4:00-9:00 pm at Tahoe Bowl located at 1030 Fremont Ave. \$4.50 games and \$4 shoes will be on special and proceeds go to support the cure.



The City of South Lake Tahoe and the County of El Dorado want your help in creating a new plan for parks, recreation facilities, and trails! Please take a few minutes to complete a Parks Survey questionnaire at www.cityofslt.us or <http://bit.ly/SLTParks>

Take the Parks Survey today!

Your input will help us make important decisions about recreation in the South Shore. This includes the City of South Lake Tahoe, the community of Meyers, and El Dorado County residents.

The online survey is available now through October 7th!
Help shape the future of your community!
www.cityofslt.us "Parks Survey"

Ribbon-Cutting Ceremony to Celebrate Grand Opening of Bijou Dog Agility Park

The City of South Lake Tahoe and the South Lake Tahoe Police Canine Association (SLTPCA) worked in partnership to install several pieces of custom dog agility equipment at Bijou Park. A Ribbon Cutting ceremony was held on Sunday, September 22nd to celebrate the opening of the Bijou Dog Agility Park.

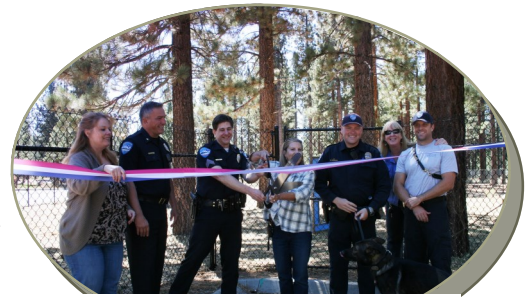

South Lake Tahoe Police K9 Officers, Josh Adler, Matt Morrison and Ryan Wagoner along

Grand Opening of Bijou Dog Park Agility Course with

Councilmember JoAnn Conner, former Mayor Kathay Lovell, City Manager Nancy Kerry, and Police Chief Brian Uhler were all in attendance to celebrate the completion of the project and ceremoniously cut the ribbon.

The Agility Park is available to the public and is an extension of the Bijou Dog Park. The only exception is when the South Lake Tahoe Police K9 Unit is training in the Agility Park and closed session training times will be posted at the agility course.

The SLTPCA is a 501(c) (3) charitable organization separate from the City of South Lake Tahoe and is the official adopter of the Agility Park. The mission of the SLTPCA is to enhance the quality of life for dogs and their owners through support of the Agility Park and the canine association equipment for the SLTPCA K-9s. The SLTPCA members help with beautification improvements at the Agility Dog Park.

**My Echo Story:
Vail Volunteers with
Bijou Community Park**



Vail Echo Day at
Bijou Community Park

By Bruce Scholes, City of SLT
Parks Manager

For the second consecutive year, Heavenly and Kirkwood Mountain Resorts and the City of South Lake Tahoe collaborated to enrich and beautify another City Community Park through the Vail Resorts Echo Day. About

250 volunteers descended on Bijou Community Park on September 21st, laying sod, planting shrubs, and spreading wood chips. Other projects include cutting unwanted pine saplings, painting picnic tables and playground equipment and overall giving the park a much needed facelift.

Last year Heavenly and Kirkwood volunteers helped complete Lakeview Commons by installing more than 9,000 square feet of sod and planting hundreds of plants.

Parks Manager Greg Ross is extremely thankful for the donations and community help contributed by Heavenly and Kirkwood through the Vail Resorts Echo program. "I think it's great that Heavenly and

Kirkwood have taken an interest in improving our park areas," Ross said. "Bijou Community Park is the perfect location. The new sod will be a nice addition to the park's many activities, which include a 36-hole disc golf course, a skateboard park, basketball/roller rink area, dog park and a new dog agility course park. The new sod will be located at the entrance of the park near the first gazebo and the playground giving families the option to picnic under the gazebo or to spread a blanket on the new grass. Children will have a new grass area where they can run and play while still being close to the playground, climbing structures, and swing sets."

City Council Meetings on October 1st & 15th
Join us for the upcoming city council meetings on Tuesday, October 1st and 15th in the City Council Chambers located at 1901 Airport Road. The City Council meeting are held on the first and third Tuesday of each month and begin at 9:00 am.

SIGN UP to Receive Emergency Alerts to your e-mail or mobile phone at www.cityofslt.us/signup

U.S. Highway 50 Improvement Project

A Ribbon Cutting Ceremony was held on Friday, September 13th at Lakeview Commons for the Trout Creek to Ski Run Blvd. improvement project. This \$43.1 Caltrans project collects and treats storm water runoff and provides substantial safety and beautification features in its final season of construction, which started in 2011.



Caltrans Highway 50
Ribbon Cutting

The project is located within the city of South Lake Tahoe on U.S. Highway 50 from Trout Creek Bridge to Ski Run Boulevard.

The project will collect and treat storm water runoff as part of the Lake Tahoe Environmental Improvement Program (EIP). It will also widen the roadway to provide 6 feet shoulders for bike lanes, replace traffic signals, and provide Americans with Disabilities Act (ADA) compliant sidewalks, pedestrian lighting and landscaping.

"Light up South Lake Tahoe"



Join us as we celebrate the 2nd Annual
Holiday Lights Event on
Saturday, December 7th at 6pm

Imagine a wave of holiday lights from Stateline to the "Y"
(and a grand finale of the tree lighting at the "Y")

For more info, visit www.cityofslt.us/lightupslt



Join in the Fun with Light up South Lake Tahoe!

The First Annual "Light up South Lake Tahoe" event took place over Thanksgiving weekend in 2012 with multiple businesses along Highway 50 participating by decorating their store fronts and turning on their lights as the South Lake Tahoe Fire Departments fire truck and Streets Department snow plow led the procession from Stateline to the "Y."

Join us for the 2nd Annual "Light up South Lake Tahoe" on Saturday, December 7th, 2013!

Businesses along Highway 50 will turn on their lights in a wave and "Light up South Lake Tahoe" as the South Lake Tahoe Fire Department truck, South Lake Tahoe Police Department Command Vehicle and Snow Plows are decorated in festive holiday lights.

Want to join in on the fun? Feel free to decorate your vehicle and follow along behind the procession.

The festivities will conclude at the "Y" with the annual tree lighting, a special visit from Santa and hot cocoa & cookies.

While an official contest was not planned in 2012, South Tahoe Standup Paddle located at 3115 Harrison Avenue did an outstanding job of decorating their storefront and are awarded the title of "Best Participation and Most Enthusiastic" by City staff.

Plans are underway to increase the size of this event. Mark your calendars for this years 2nd Annual "Light up South Lake Tahoe" which will be held on Saturday, December 7, 2013 at 6:00 pm.

For more information, visit us online at www.cityofslt.us/lightupslt

CITY OF SOUTH LAKE TAHOE

Administrative Offices
 1901 Airport Road
 South Lake Tahoe, CA 96150

Phone: (530) 542-6000



We're on the Web!

City website
www.cityofslt.us
 City Facebook page
<https://www.facebook.com/OfficialCityofSouthLakeTahoe>
 City Twitter page
<https://twitter.com/cityofslt>

OCTOBER 2013

| SUN | MON | TUE | WED | THU | FRI | SAT |
|-----------------------------------------------|--------------------------------------|------------------------------------------|-------------------------------|-----|-------------------------------------------|-----------------------------------------|
| | | 1 City Council mtg @ 9am | 2 Citizens Academy @ 5:30 | 3 | 4 | 5 K9 Trials @ Babe Ruth Fields @ 8am |
| 6 | 7 | 8 Parks & Rec Commission mtg @ 3:30pm | 9 Citizens Academy @ 5:30 | 10 | 11 | 12 |
| 13 | 14 HOLIDAY City Offices Closed | 15 City Council mtg @ 9am | 16 Citizens Academy @ 5:30 | 17 | 18 | 19 |
| 20 National Lead Poisoning Prevention week | 21 | 22 | 23 Citizens Academy @ 5:30 | 24 | 25 SLTFD Fundraiser @ Tahoe Bowl 4-9pm | 26 |
| 27 | 28 | 29 | 30 Citizens Academy @ 5:30 | 31 | | |

South Lake Tahoe Police K9 Trials on October 5th



The South Lake Tahoe Police Canine Association (SLTPCA) will be holding the 2013 K9 Trials on Saturday, October 5th beginning at 8am at the Babe Ruth Baseball fields located at 1090 Lyons Ave. in South Lake Tahoe.

Help support the SLTPCA by purchasing a brick to be placed in the Bijou Agility Dog Park. The SLTPCA is a 501(c) (3) charitable organization separate from the City of South Lake Tahoe and is the official adopter of the Agility Park. The mission of the SLTPCA is to enhance the quality of life

for dogs and their owners through support of the Agility Park and the canine association equipment for the SLTPCA K-9s. The SLTPCA members help with beautification improvements at the Agility Dog Park. For more information, send an e-mail to bricks@sltpca.org

Important Phone Numbers

| | |
|--------------------------|----------|
| Campground by the Lake | 542-6096 |
| City Offices | 542-6000 |
| Bijou Golf | 542-6097 |
| Building dept. | 542-6010 |
| Business License | 542-6012 |
| Explore Tahoe | 542-4637 |
| Fire non-emergency | 542-6160 |
| Ice Arena | 544-7465 |
| Lake Tahoe Airport | 542-6182 |
| Lead Safe Tahoe | 542-6011 |
| Parks/Recreation Complex | 542-6056 |
| Planning dept. | 542-6020 |
| Police non-emergency | 542-6100 |
| Senior Center | 542-6094 |
| Streets | 542-6030 |

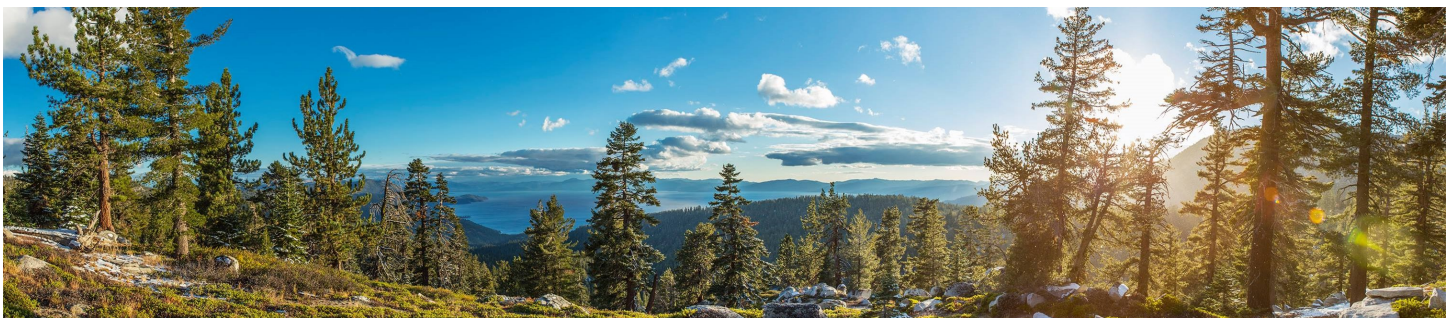

"Another Beautiful Tahoe Day" - Mayor Tom Davis

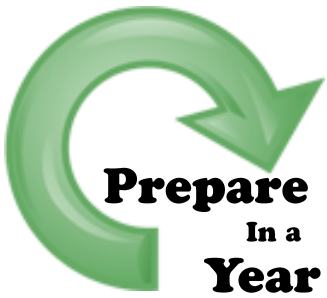

Home Hazard Hunt

| | | | |
|--|----|--|--|
| | | | |
| | | | |
| | 10 | | |

Emergency Preparedness—Month 10 Identifying potential home hazards

All of California has the potential of being impacted by a major earthquake. Earthquakes strike suddenly and without warning. When they occur, they cause the ground to undulate and shake, perhaps violently. Buildings – and their contents – are vulnerable to this rocking and rolling. Fortunately, experts teach how to secure homes to their foundations, and contents to wall studs.



30 Minutes Well Spent

Take 30 minutes to walk through your home. Imagine the ground movement of a significant earthquake. Identify potential hazards by completing this worksheet.

1. Check your water heater. Is it securely fastened to the wall studs with heavy-duty metal strapping, top and bottom (and not metal plumber's tape)?

____yes ____no

Does your water heater have flexible water and gas connectors?

____yes ____no

2. Tall pieces of furniture are especially vulnerable in earthquakes. Identify each bookcase, china hutch, and armoire which needs fastening.

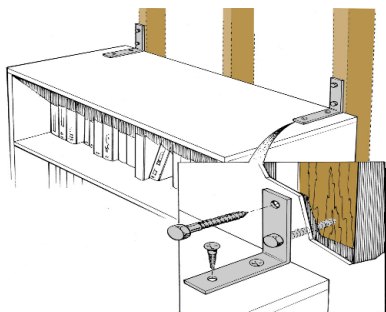

3. Identify heavy or breakable objects on high shelves. Pay especial attention to objects with sentimental value.

(Move heavy objects that are located on high shelves to low shelves.)

4. Identify computers, stereos, and televisions, and microwaves and other small appliances that need to be secured.

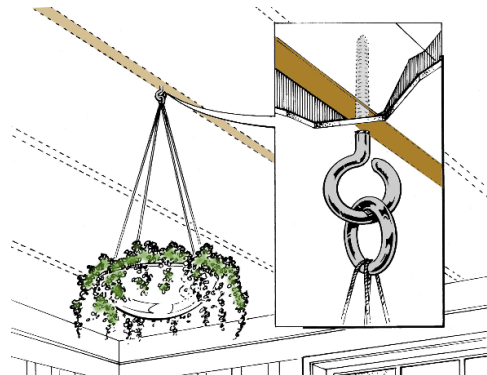

5. Identify hanging plants, especially in heavy baskets, and hanging lights near windows.

6. Identify mirrors, heavily-framed pictures, and framed artwork that needs to be secured to wall studs.

(Pay especial attention to artwork, pictures, and mirrors over beds. Consider moving these to another location.)

7. Identify kitchen, bedroom, and garage cabinets that need to be secured to keep their contents inside during the ground shaking.

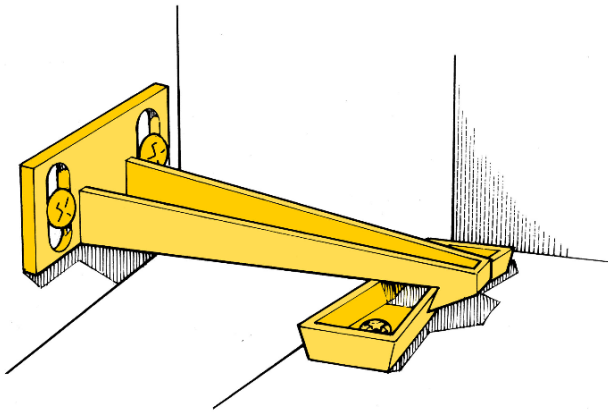

8. Inspect the foundation of your home. Is your home securely fastened to it?

____yes ____no

(Check with the City's Building Department for permits and regulations.)

9. Does your chimney have loose bricks?

____yes ____no

Has your attic been reinforced with ply wood to help prevent chimney bricks from falling into living areas?

____yes ____no

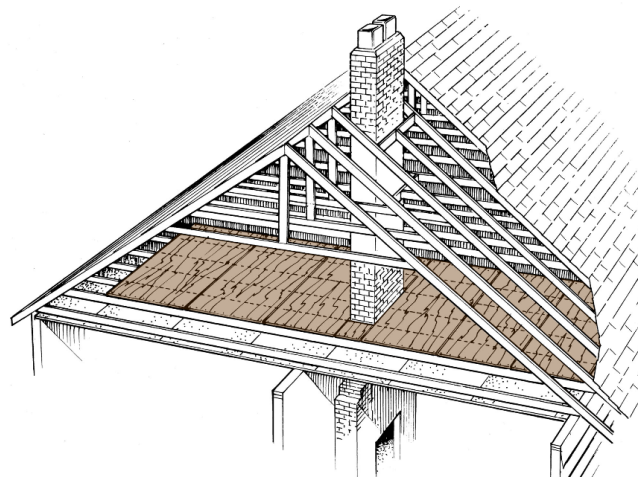

10. Identify poisons, toxics, or solvents in breakable containers that are located in high or dangerous locations.



City of South Lake Tahoe Emergency Preparation

As part of the City's initiative to increase communications, we will be offering a 12 part monthly series during 2013 highlighting emergency preparedness. Use these tools to prepare yourself for an emergency.